

TRAILING EDGE PRODUCT - MINIMUM ORDER APPLIES



Elm Road, West Chirton, NORTH SHIELDS, Tyne & Wear
NE29 8SE, England Tel. +44 (0191) 2930500 Fax.+44 (0191)
2590997

8M x 8 SRAM MODULE

SYS88000RKX - 70/85/10/12

Issue 1.4 : January 1999

Description

The SYS88000RKX is a plastic 64Mbit Static RAM Module housed in a standard 38 pin Single In-Line package organised as 8M x 8 with access times of 70, 85, 100, or 120 ns.

The module is constructed using sixteen 512Kx8 SRAMs in TSOPII packages mounted onto both sides of an FR4 epoxy substrate. This offers an extremely high PCB packing density.

The device is offered in standard and low power versions, with the -L module having a low voltage data retention mode for battery backed applications. On board buffering is provided to reduce output capacitance.

Note: \overline{CS} and \overline{OE} on the module, should be used with care to avoid on and off board bus contention.

Features

- Access Times of 70/85/100/120 ns.
- Low Power Disipation:

Operating	935 mW (Max.)
Standby -L Version	11 mW (Max.)
- 5 Volt Supply $\pm 10\%$.
- Completely Static Operation.
- Equal Access and Cycle Times.
- Low Voltage V_{CC} Data Retention.
- On-board Decoding & Capacitors.
- 38 Pin Single-In-Line package.
- Upgrade from SYS84000RKX (32Mbit).

Block Diagram

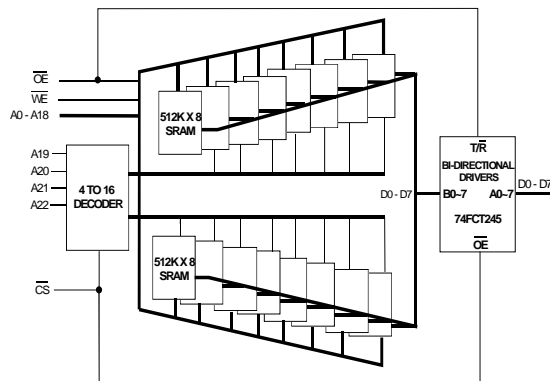

Pin Definition

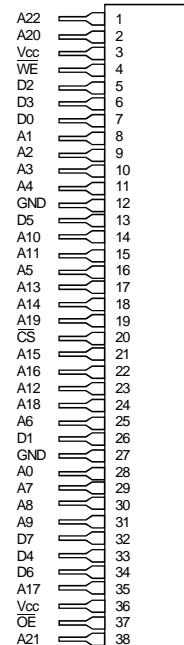

Pin Functions

Address Inputs	A0 ~ A22
Data Input/Output	D0 ~ D7
Chip Select	\overline{CS}
Write Enable	\overline{WE}
Output Enable	\overline{OE}
No Connect	NC
Power (+5V)	V_{CC}
Ground	GND

Package Details

Plastic 38 pin Single-In-Line (SIP)

Absolute Maximum Ratings ⁽¹⁾

Parameter	Symbol	Min	Typ	Max	Unit
Voltage on any pin relative to V_{SS}	$V_T^{(2)}$	-0.3	-	7.0	V
Power Dissipation	P_T	-	1.0	-	W
Storage Temperature	T_{STG}	-55	-	125	°C

Notes : (1) Stresses above those listed may cause permanent damage to the device. This is a stress rating only and functional operation of the device at those or any other conditions above those indicated in the operational sections of this specification is not implied. Exposure to absolute maximum rating conditions for extended periods may affect device reliability.

(2) V_T can be -3.0V pulse of less than 30ns.

Recommended Operating Conditions

Parameter	Symbol	Min	Typ	Max	Unit
Supply Voltage	V_{CC}	4.5	5.0	5.5	V
Input High Voltage	V_{IH}	2.2	-	$V_{CC}+0.3$	V
Input Low Voltage	V_{IL}	-0.3	-	0.8	V
Operating Temperature (Commercial)	T_A	0	-	70	°C
(Industrial)	T_{AI}	-40	-	85	°C

DC Electrical Characteristics ($V_{CC}=5V\pm 10\%$)

TA 0 to 70 °C

Parameter	Symbol	Test Condition	Min	Typ	max	Unit
I/P Leakage Current Address, \overline{OE} , \overline{WE}	I_{LI}	$0V \leq V_{IN} \leq V_{CC}$	-16	-	16	μA
Output Leakage Current	I_{LO}	$\overline{CS} = V_{IH}, V_{IO} = GND \text{ to } V_{CC}$	-16	-	16	μA
Operating Current	I_{CC1}	Min. Cycle, $\overline{CS} = V_{IL}, V_{IL} \leq V_{IN} \leq V_{IH}$	-	-	170	mA
Standby Supply Current TTL levels	I_{SB1}	$\overline{CS} = V_{IH}$	-	-	48	mA
CMOS levels	I_{SB2}	$\overline{CS} \geq V_{CC}-0.2V, 0.2 \leq V_{IN} \leq V_{CC}-0.2V$	-	-	32	mA
-L Version (CMOS)	I_{SB3}	$\overline{CS} \geq V_{CC}-0.2V, 0.2 \leq V_{IN} \leq V_{CC}-0.2V$	-	-	2	mA
Output Voltage	V_{OL}	$I_{OL} = 8.0mA$	-	-	0.4	V
	V_{OH}	$I_{OH} = -4.0mA$	2.4	-	-	V

Typical values are at $V_{CC}=5.0V, T_A=25^\circ C$ and specified loading.

Add 800mA to -L CMOS standby currents to obtain industrial temp range parameters.

Capacitance ($V_{CC}=5V\pm 10\%, T_A=25^\circ C$)

Note: Capacitance calculated, not measured.

Parameter	Symbol	Test Condition	max	Unit
Input Capacitance (Address, \overline{OE} , \overline{WE})	C_{IN1}	$V_{IN} = 0V$	128	pF
I/P Capacitance (other)	C_{IN2}	$V_{IN} = 0V$	10	pF
I/O Capacitance	C_{IO}	$V_{IO} = 0V$	160	pF

AC Test Conditions**Output Load**

- * Input pulse levels: 0V to 3.0V
- * Input rise and fall times: 5ns
- * Input and Output timing reference levels: 1.5V
- * Output load: see diagram
- * $V_{CC} = 5V \pm 10\%$

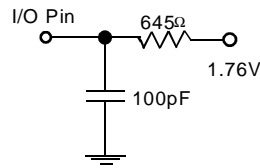
**Operation Truth Table**

\overline{CS}	\overline{OE}	\overline{WE}	DATA PINS	SUPPLY CURRENT	MODE
H	X	X	High Impedance	$I_{SB1}, I_{SB2}, I_{SB3}, I_{SB4}$	Standby
L	L	L	Invalid State	~	Invalid
L	L	H	Data Out	I_{CC1}	Read
L	H	L	Data In	I_{CC1}	Write
L	H	H	High-Impedance	I_{CC1}	High-Z

Notes : $H = V_{IH}$: $L = V_{IL}$: $X = V_{IH}$ or V_{IL}
 \overline{OE} must not be tied low permanently.

Low V_{CC} Data Retention Characteristics - L Version Only

Parameter	Symbol	Test Condition	min	typ ⁽¹⁾	max	Unit
V_{CC} for Data Retention	V_{DR}	$\overline{CS} \geq V_{CC} - 0.2V$	2.0	-	-	V
Data Retention Current	$I_{CCDR1}^{(2)}$	$V_{CC} = 3.0V, \overline{CS} \geq V_{CC} - 0.2V$	-	-	1.2	mA
Chip Deselect to Data Retention Time	t_{CDR}	See Retention Waveform	0	-	-	ns
Operation Recovery Time	t_R	See Retention Waveform	5.0	-	-	ms

Notes

- (1) Typical figures are measured at 25°C.
- (2) This parameter is guaranteed not tested.
- (3) Add 840mA to -L CMOS standby currents to obtain industrial temp range parameters.

AC OPERATING CONDITIONS

Read Cycle

Parameter	Symbol	-70		-85		-10		-12		Unit
		min	max	min	max	min	max	min	max	
Read Cycle Time	t_{RC}	70	-	85	-	100	-	120	-	ns
Address Access Time	t_{AA}	-	70	-	85	-	100	-	120	ns
Chip Select Access Time	t_{ACS}	-	70	-	85	-	100	-	120	ns
Output Enable to Output Valid	t_{OE}	-	40	-	50	-	55	-	60	ns
Output Hold from Address Change	t_{OH}	11.5	-	11.5	-	11.5	-	11.5	-	ns
Chip Selection to Output in Low Z	t_{CLZ}	1.5	-	1.5	-	1.5	-	1.5	-	ns
Output Enable to Output in Low Z	t_{OLZ}	1.5	-	1.5	-	1.5	-	1.5	-	ns
Chip Deselection to O/P in High Z	t_{CHZ}	0	5	0	5	0	5	0	5	ns
Output Disable to Output in High Z	t_{OHZ}	0	5	0	5	0	5	0	5	ns

Write Cycle

Parameter	Symbol	-70		-85		-10		-12		Unit
		min	max	min	max	min	max	min	max	
Write Cycle Time	t_{WC}	70	-	85	-	100	-	120	-	ns
Chip Selection to End of Write	t_{CW}	60	-	75	-	80	-	100	-	ns
Address Valid to End of Write	t_{AW}	60	-	75	-	80	-	100	-	ns
Address Setup Time	t_{AS}	0	-	0	-	0	-	0	-	ns
Write Pulse Width	t_{WP}	50	-	60	-	70	-	70	-	ns
Write Recovery Time	t_{WR}	5	-	5	-	5	-	5	-	ns
Write to Output in High Z	*** t_{WHZ}	0	30	0	35	0	40	0	40	ns
Data to Write Time Overlap	t_{DW}	35	-	40	-	45	-	45	-	ns
Data Hold from Write Time	t_{DH}	0	-	0	-	0	-	0	-	ns
Output active from end of write	*** t_{OW}	5	-	5	-	5	-	5	-	ns

*** These signals are the internal Ram signals on the module and are included to assist control signal timing.

Read Cycle Timing Waveform ^(1,2)

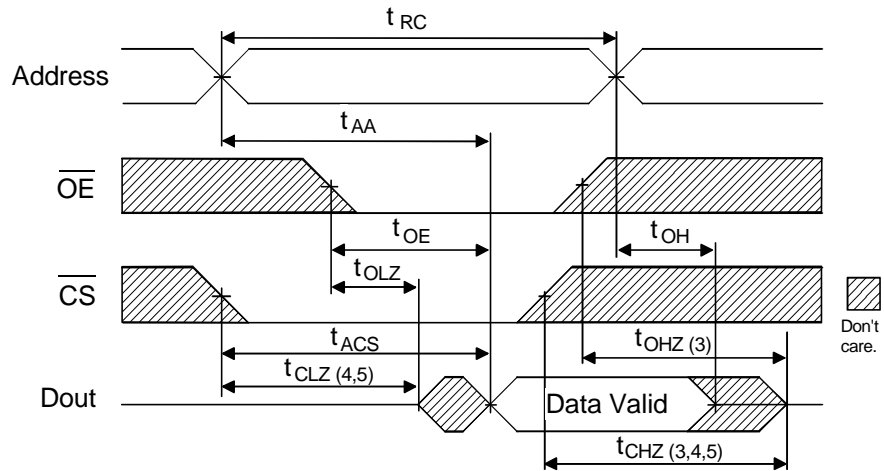

AC Read Characteristics Notes

- (1) \overline{WE} is High for Read Cycle.
- (2) All read cycle timing is referenced from the last valid address to the first transition address.
- (3) t_{CHZ} and t_{OHZ} are defined as the time at which the outputs achieve open circuit conditions and are not referenced to output voltage levels.
- (4) At any given temperature and voltage condition, t_{CHZ} (max) is less than t_{CLZ} (min) both for a given module and from module to module.
- (5) These parameters are sampled and not 100% tested.

Write Cycle No.1 Timing Waveform ^(1,4)

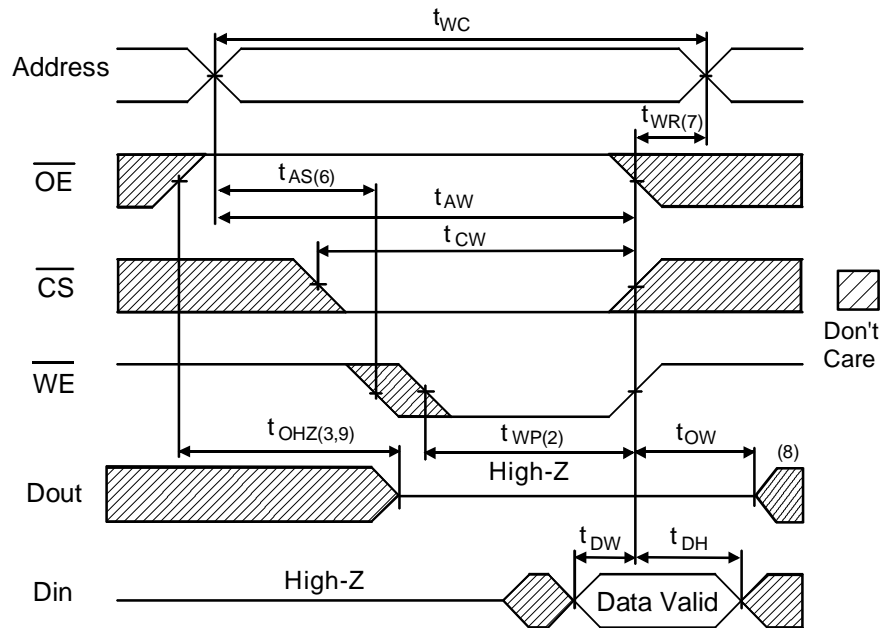

Package Information Dimensions in mm

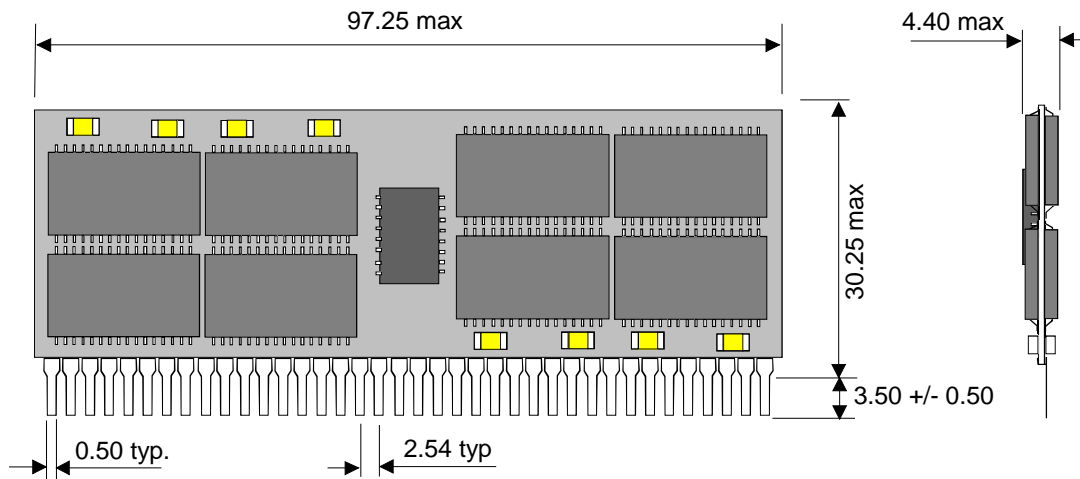

Ordering Information

SYS88000RKXLI - 70

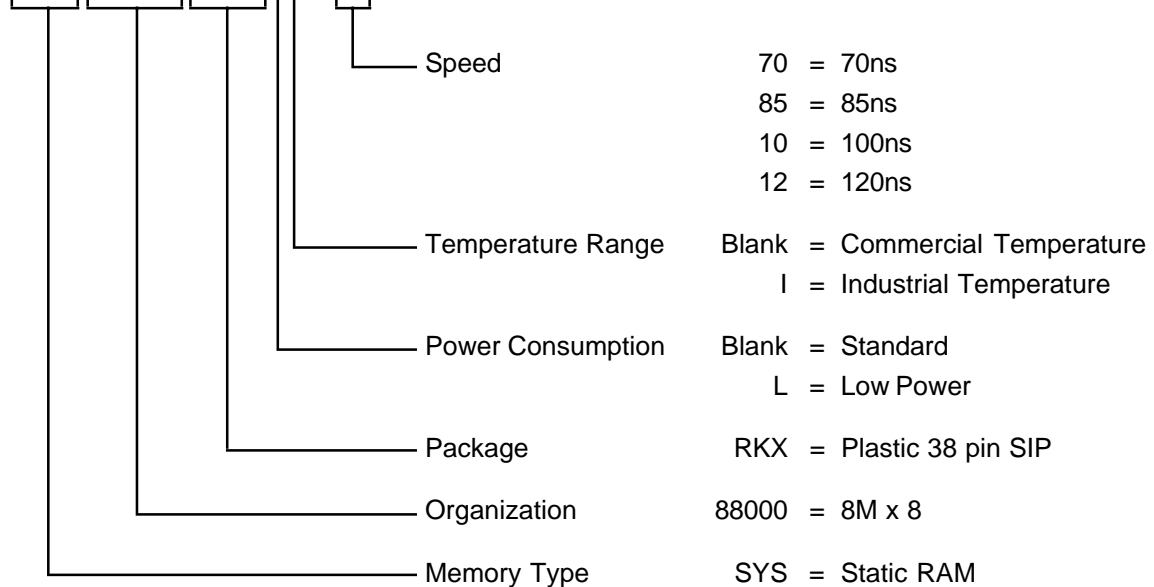

Note :

Although this data is believed to be accurate the information contained herein is not intended to and does not create any warranty of merchantability or fitness for a particular purpose.
 Our Products are subject to a constant process of development. Data may be changed at any time without notice.
 Products are not authorised for use as critical components in life support devices without the express written approval of a company director